

# Body Cardio

Weight & body composition - Heart Rate and Pulse Wave Velocity - Daily report

Installation and operating instructions



# Table of contents

---

<b>Minimum requirements</b> .....	<b>4</b>
Internet access.....	4
Smartphone or device .....	4
OS version.....	4
Health Mate app version .....	4
<b>Body Cardio description</b> .....	<b>5</b>
Overview.....	5
Box contents.....	5
Product description .....	6
Scales screens description.....	6
<b>Setting up the Body Cardio</b> .....	<b>8</b>
Installing the Health Mate app.....	8
Installing your Body Cardio.....	8
<b>Customizing your Body Cardio</b> .....	<b>18</b>
Changing the configuration of your Body Cardio.....	18
Changing the settings of your Body Cardio .....	21
<b>Using your Body Cardio</b> .....	<b>27</b>
Tracking your weight and body composition.....	27
Tracking your heart rate.....	34
Tracking your Pulse Wave Velocity.....	35
Checking the weather .....	37
Using Baby mode.....	38
Using Pregnancy mode.....	40
<b>Linking your account to MyFitnessPal</b> .....	<b>42</b>
<b>Syncing your data</b> .....	<b>44</b>
<b>Dissociating your Body Cardio</b> .....	<b>45</b>
<b>Performing a factory reset of your Body Cardio</b> .....	<b>47</b>
<b>Cleaning and maintenance</b> .....	<b>48</b>
Cleaning your Body Cardio .....	48

Charging the battery .....	48
Updating your Body Cardio .....	48
<b>Technology description .....</b>	<b>50</b>
Weight .....	50
Body composition.....	50
Heart rate .....	50
Pulse Wave Velocity.....	50
<b>Specifications .....</b>	<b>51</b>
<b>User guide copyright.....</b>	<b>53</b>
<b>Legal notice.....</b>	<b>53</b>
Personal data.....	53
<b>Safety instructions.....</b>	<b>54</b>
Use and storage .....	54
Service and maintenance .....	54
<b>Document release overview .....</b>	<b>55</b>
<b>Warranty.....</b>	<b>56</b>
<b>Regulatory Statements.....</b>	<b>57</b>

# Minimum requirements

---

## Internet access

Access to the Internet is required to:

- Download the Health Mate app,
- Set up your Body Cardio,
- Upgrade your product whenever an update is available.

For more details, refer to [“Specifications” on page 51](#). We recommend using the app on a device connected to the Internet to enjoy all features.

## Smartphone or device

An iOS device or an Android device (with operational Bluetooth and Wi-Fi or 3G/4G) is required to:

- Set up your Body Cardio,
- Retrieve data from your Body Cardio,
- Access specific functions of your Body Cardio.

Bluetooth Low Energy (BLE) compatibility is recommended to install your Nokia Body Cardio. For more details, refer to [“Specifications” on page 51](#).

## OS version

You need iOS 8 or above to install and run the Health Mate App on an iOS device.

You need Android 5.0 or above to install and run the Health Mate App on an Android device.

## Health Mate app version

We recommend that you use the latest available version of the Health Mate app to have all the latest features available.

# Body Cardio description

---

## Overview

With its slick and extra thin design, the Body Cardio allows you to easily track your weight and monitor your progress. Additionally, it calculates your fat mass, muscle mass, bone mass and water mass by bioelectric impedance to inform you about your body composition.

Of course that's not all your Body Cardio does. It provides you with information about your body composition (fat mass, muscle mass, bone mass and water, your heart rate and your Pulse Wave Velocity, a key indicator of cardiovascular health. If you activate the Weather screen, you also get your daily weather report everytime you weigh in.

Because the Body Cardio is a connected scale, its true potential is achieved when you use it along with the Health Mate app. Beside allowing you to install your scale, the Health Mate app allows you to customize its display, to set a weight goal, and to check the entire history of your weight data.

Thanks to its in-app activity tracking feature and the numerous partner apps you can connect it to, the Health Mate app helps you reach your health goals faster by helping you track your activity and check your calorie balance.

## Box contents

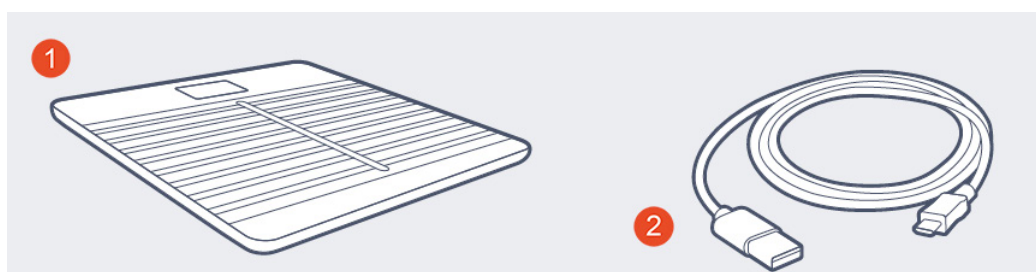

(1) Body Cardio

(2) USB cable

## Product description

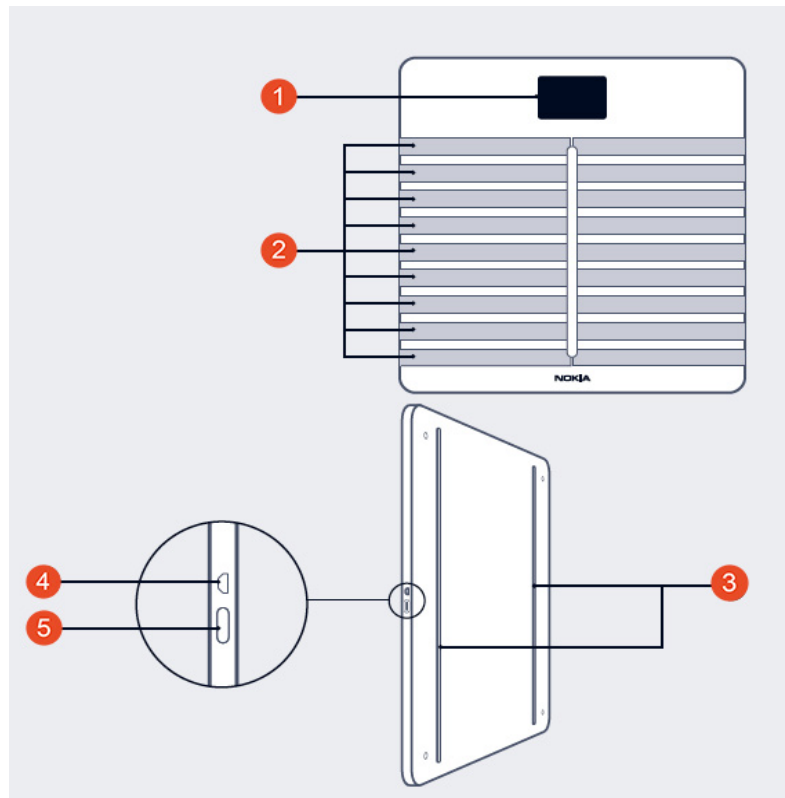

(1) Display

(2) Electrodes

(3) Feet

(4) Micro USB port

(5) Pairing and units  
button

## Scales screens description

You can select a number of screens to be displayed on your Body Cardio:

- **Weight:** Displays your weight. This screen cannot be disabled.
- **Fat Mass:** Displays your percentage of fat mass.
- **Water:** Displays your percentage of water.
- **Bone mass:** Displays the weight of your bones.
- **Muscle mass:** Displays the weight of your muscles.
- **Weather<sup>1</sup>:** Displays the weather for the day.
- **Heart Rate:** Displays your heart rate.
- **Weight Trend<sup>1</sup>:** Displays a graph with your last 8 weight measurements.
- **Steps<sup>1,2</sup>:** Displays the number of steps you did the previous day.

You can disable or change the order of these screens as you like after you install your Body Cardio. Otherwise, they will appear in the default order. Refer to [“Changing the screen order” on page 22](#) for more information.

<sup>1</sup> This screen can only be used if you set up your Body Cardio in Wi-Fi.

<sup>2</sup> You either need to own a Withings tracker, or to use the in-app tracking of the Health Mate app to display your number of steps on this screen. If you don't have a Withings tracker, tap on Activity in your Dashboard in the Health Mate app and tap **Activate now**. Your mobile device will then start tracking your steps.

# Setting up the Body Cardio

---

## Installing the Health Mate app

If the Health Mate app is not already installed on your device, perform the following steps:

1. Type [go.withings.com](https://go.withings.com) in your device's web browser.
2. Tap **Download** on the App Store or on the Play Store.
3. Tap **GET**.  
The installation process starts.

## Installing your Body Cardio

### Overview

Installing your Body Cardio in Wi-Fi gives you access to all the features and screens available. Installing your Body Cardio in Bluetooth limits the features and screens available. For example, you can't use the Weather screen and the Steps screen, as they require access to the Internet.

You can change the configuration of your Body Cardio anytime you want. Refer to "[Changing the configuration of your Body Cardio](#)" on page 18 for more information.

Note that once you've installed your Body Cardio on your account, all the users of the account can use it. You are also free to install it on various account. There is, however, a limit of eight users per scale at the moment.



## Installing your Body Cardio without an existing account

Refer to “Installing your Body Cardio with an existing account” on page 13 if you already have a Withings account.

1. Press and hold the side button for three seconds.

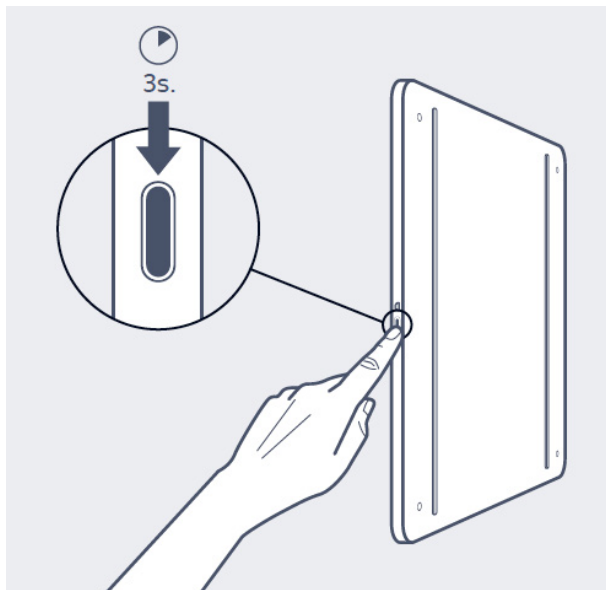

The scale displays [go.withings.com](https://go.withings.com).

2. Open the Health Mate app.
3. Tap **Get started**.

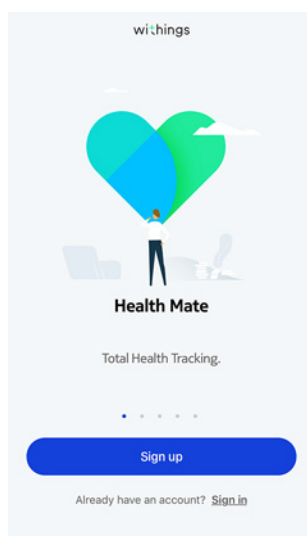

4. Tap **Scales**.

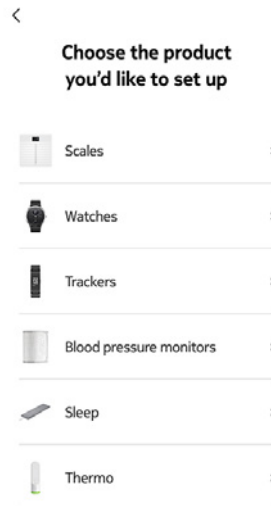

5. Tap **Body Cardio**.

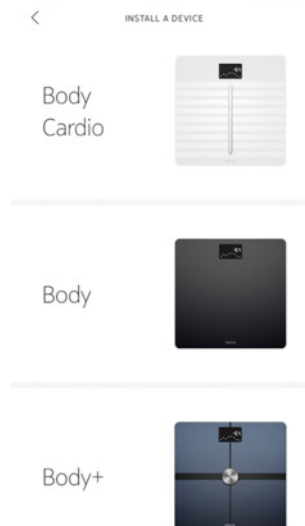

6. Tap **Install**.



7. Tap the Body Cardio you want to install.

It may take up to a minute for your scale to be detected by your mobile device.

If your Body Cardio is not displayed in the list, go to the Bluetooth settings of your device and pair it from there. It should now appear in the Health Mate app.

8. Press and hold the side button for three seconds and tap **Next**.
9. Tap **Next**.



10. Tap **Pair** twice.

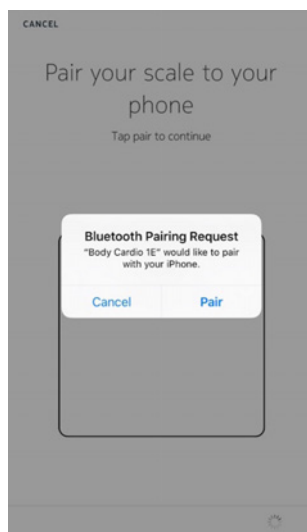

11. Tap **Next**.
12. Enter your email address, password, and then confirm your password. Tap **Next**.
13. Enter your first name, surname (last name) and birthday. Tap **Next**.
14. Select your gender and enter your current height and weight. Tap **Create**. This information is necessary for the calculation of your BMI. It also allows your Body Cardio to recognize you based on your weight the first time you weigh in.
15. If you want your scale to sync in Wi-Fi once it's installed, perform the following steps:

- a. Tap **Quick setup** to use the same Wi-Fi network as your mobile device or **Setup another network** to use another one.



- b. Tap **Allow**.

You will need to update the Wi-Fi configuration if you change the network name or password. Refer to [“Changing the configuration of your Body Cardio” on page 18](#) for more information.

16. If you want your scale to sync in Bluetooth only once it's installed, tap **I don't have a Wi-Fi Network**.
17. Tap **Done**.



The Health Mate now prompts you to select your target weight. Tap **Cancel** if you don't want to set a weight goal. You can set one later on if you change your mind. Refer to [“Changing your weight goal” on page 29](#) for more information.

## Installing your Body Cardio with an existing account

1. Press and hold the side button for three seconds.

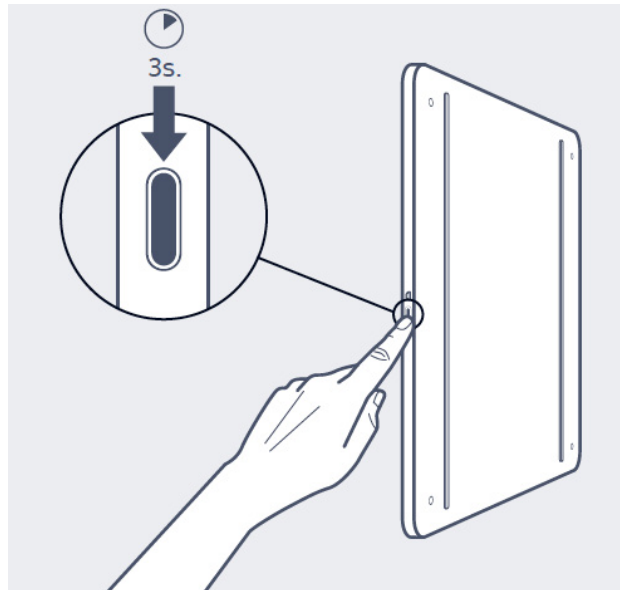

The scale displays [go.withings.com](https://go.withings.com).

2. Open the Health Mate app.
3. Go to **Devices**.
4. Tap **+**.

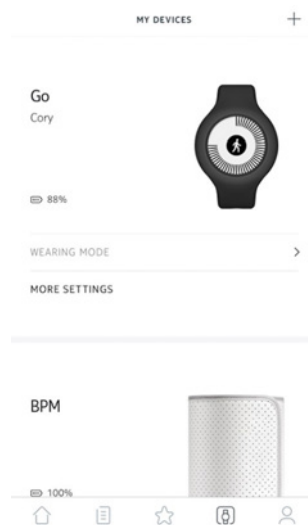

5. Tap **Scales**.

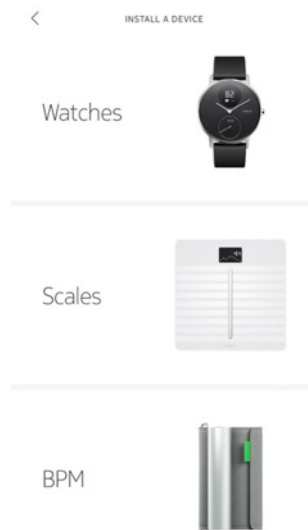

6. Tap **Body Cardio**.

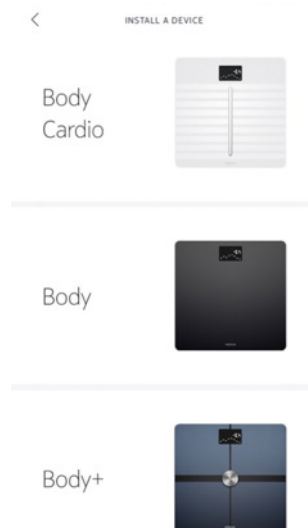

7. Tap **Install**.



8. Press and hold the side button for three seconds and tap **Next**.

9. Tap **Next**.

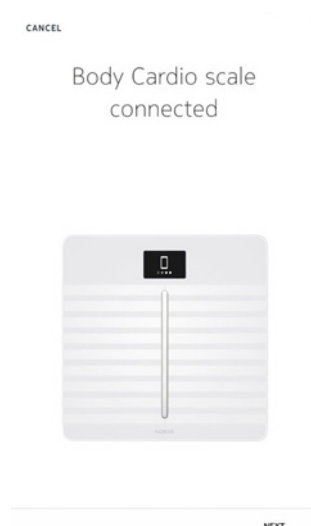

10. Tap **Pair** twice.

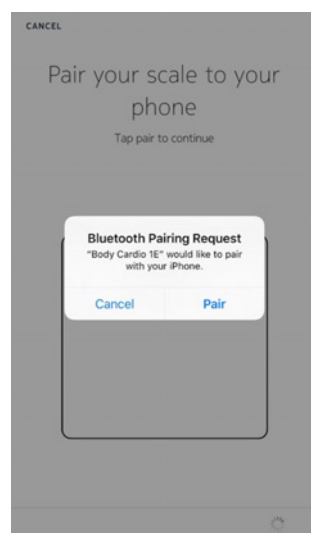

11. Tap **Next**.

12. Enter your email address, password and confirm your password. Tap **Next**.

13. Enter your first name, surname and birthday. Tap **Next**.

14. Select your gender and enter your height and weight. Tap **Create**.

15. If you want your scale to sync in Wi-Fi once it's installed, perform the following steps:

- a. Tap **Quick setup** to use the same Wi-Fi network as your mobile device or **Setup another network** to use another one.

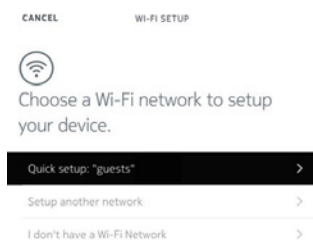

- b. Tap **Allow**.

You will need to update the Wi-Fi configuration if you change the network name or password. Refer to [“Changing the configuration of your Body Cardio” on page 18](#) for more information.

16. If you want your scale to sync in Bluetooth only once it's installed, tap **I don't have a Wi-Fi Network**.
17. Tap **Done**.



The Health Mate now prompts you to select your target weight.



## Selecting your weight goal

To select your weight goal, perform the following steps:

1. Tap and slide up or down to select your target weight.

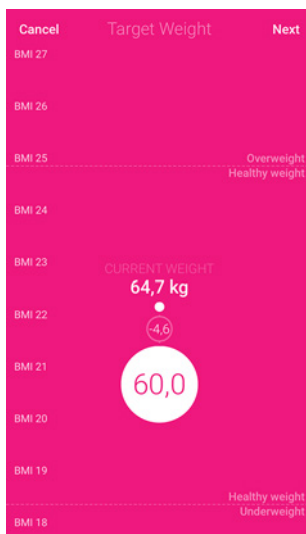

2. Tap **Next**.
3. Tap and slide up or down to select the pace at which you want to achieve your weight goal.

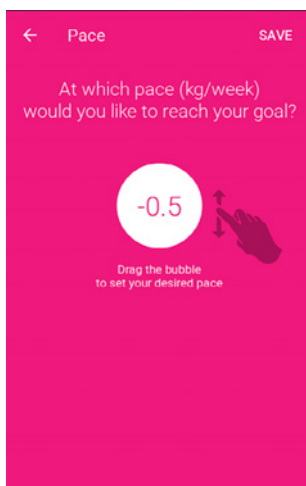

4. Tap **OK**.

# Customizing your Body Cardio

## Changing the configuration of your Body Cardio

You may need to change the configuration of your Body Cardio:

- If you want to use a different Wi-Fi network,
- If you've changed the name or password of the Wi-Fi network you use,
- If you want to switch from a Bluetooth configuration to a Wi-Fi configuration,
- If you want to switch from a Wi-Fi configuration to a Bluetooth configuration.

To change your configuration, perform the following steps:

1. Open the Health Mate app.
2. Go to **Devices**.
3. Tap **Body Cardio**.

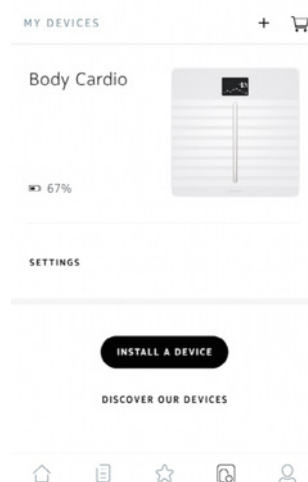

4. Tap **Update Wi-Fi Configuration**.

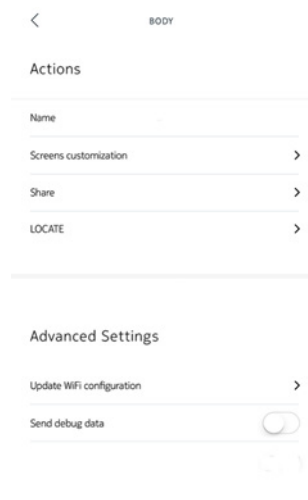

5. Press and hold the side button for three seconds and tap **Next**.

6. Tap **Next**.

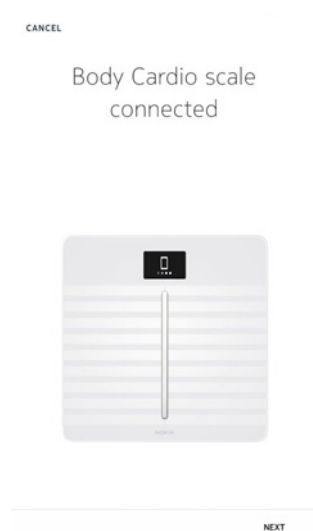

7. To switch to a Wi-Fi configuration or to update the Wi-Fi network:
- Tap **Quick setup** to use the same Wi-Fi network as your mobile device or **Setup another network** to use another one.

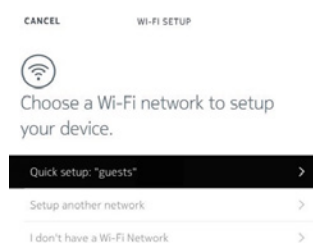

- Tap **Allow**.
8. To switch to a Bluetooth configuration, tap **I don't have a Wi-Fi Network**.

9. Tap **Done**.

You're all set!

Enjoy your new Body Cardio scale.



DONE

# Changing the settings of your Body Cardio

## Changing the weight unit

You have the choice between three weight units: kilogram (kg), stone (stlb) and pound (lb). To change the units on your Body Cardio, perform the following steps:

1. Press the button on the side of your Body Cardio.
2. Check the screen of your scale to view the unit currently selected.
3. Press the button again to move the arrow to the correct unit.  
The unit change is confirmed a few seconds after you stop pressing the button.

## Changing the temperature unit

While you can change the weight unit directly from your Body Cardio, the temperature unit (used in the Weather screen) can only be changed from the Health Mate app. By default, the temperature unit is based on the language of the app. To change the temperature unit, perform the following steps:

1. Open the Health Mate app.
2. Go to **Settings**.
3. Tap **Units**.

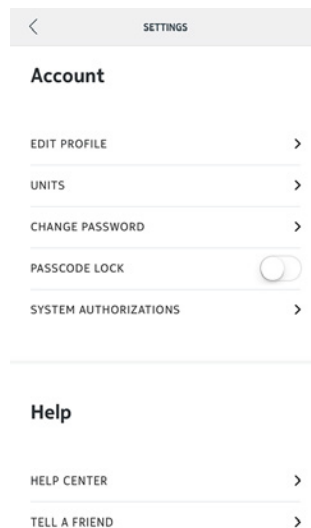

4. Select the temperature unit you want.  
You can also change the weight unit from this screen but it will only affect the display in the Health Mate app. The weight unit on the Body Cardio can only be changed from the scale itself. Refer to [“Changing the weight unit” on page 21](#) for more information.
5. Tap the back button to confirm.  
You will need to weigh in once more before the change is taken into account on your scale.

## Changing the screen order

You can change the order of the screens of your Body Cardio, for example if you want to display the Weather screen first. To do so, perform the following steps:

1. Open the Health Mate app.
2. Go to **Devices**.
3. Tap **Body Cardio**.

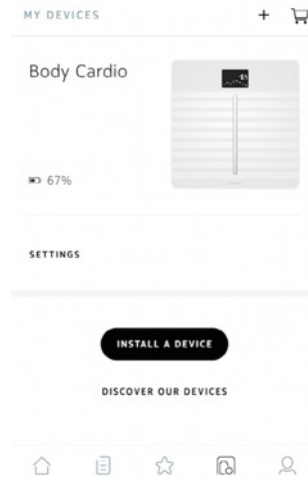

4. Tap **Screens customization**.

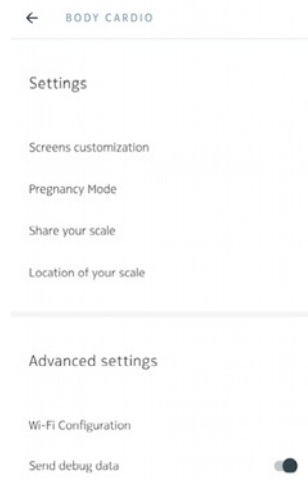

5. Tap the user profile for which you want to change the screen order.
6. Select the screens you want to display:

- Tap the blue circles on the left to hide a screen.
- Tap the empty circles on the left to display a screen.

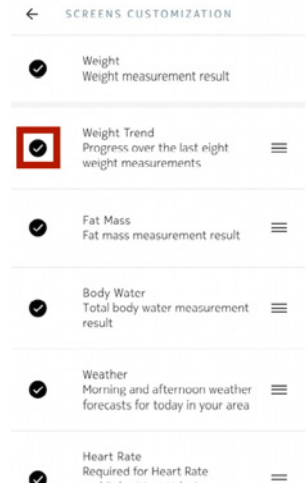

7. Tap and hold the icon on the right to drag a screen up or down.

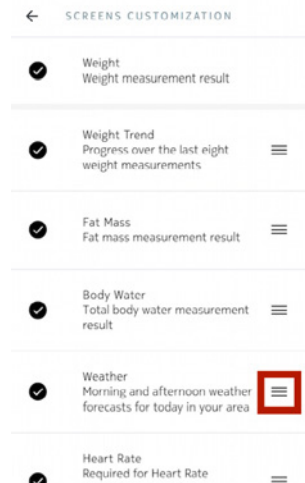

8. Tap the back button to confirm.
9. Weigh yourself once to synchronize your Body Cardio with your app and finalize the change.  
The change will take effect upon your next weigh-in.

## Changing the location of your scale

The location of your scale is used to provide you with the correct weather forecast if you have activated the Weather screen. It is based on your IP address but it is not always accurate. If the preset location of your scale happens to be incorrect, you are free to change it anytime you want. To do so, perform the following steps:

1. Open the Health Mate app.
2. Go to **Devices**.
3. Tap **Body Cardio**.

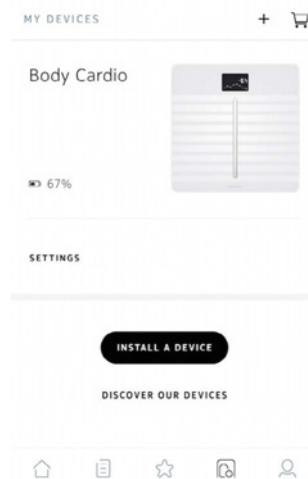

4. Tap **Location of your scale**.
5. Enter the correct location of your scale and tap **OK**.

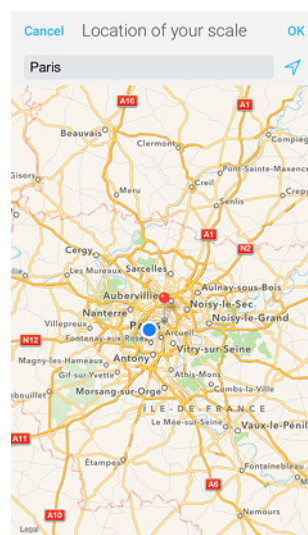

## Disabling body composition and heart rate measurement

You can disable body composition (fat mass, muscle mass, bone mass and water mass) and heart rate measurement if you choose to. This is recommended for pregnant women and mandatory for anyone wearing a pacemaker.



The body composition measurements, including fat mass, muscle mass, bone mass and hydration, should not be used by people wearing a pacemaker. Users with any other internal medical device should not use these functions of the Body Cardio scale without consulting a medical professional.

To disable these measurements, perform the following steps:

1. Open the Health Mate app.
2. Go to **Devices**.
3. Tap **Body Cardio**.

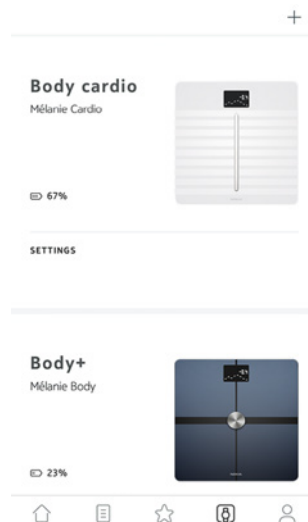

4. Tap **Fat mass and heart rate measurement**.

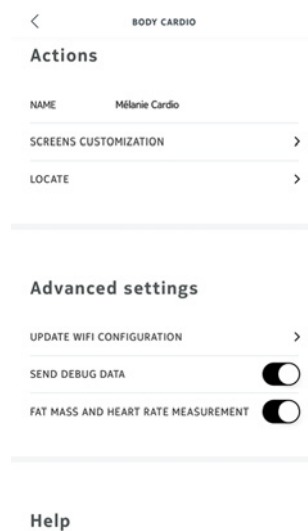

5. Tap the back button to confirm.

## Using the Athlete mode

Athletes generally have a different body type which requires a specific fat mass calculation algorithm. If you work out more than 8 hours a week and have a resting heart rate below 60 bpm, you may need to use the Athlete mode. To do so, perform the following steps:

1. Open the Health Mate app.
2. Go to **Profile**.

### 3. Tap **Settings**.

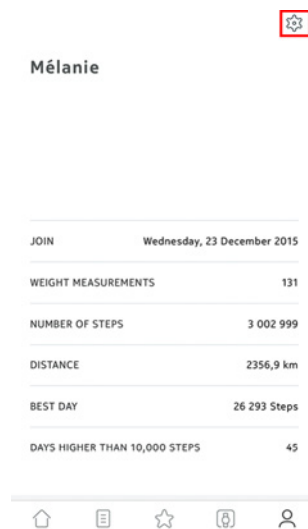

### 4. Tap **Athlete**.

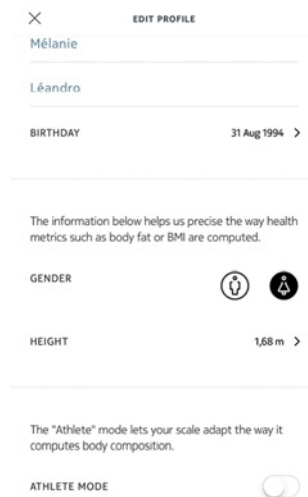

# Using your Body Cardio

---

## Tracking your weight and body composition

### Overview

The Body Cardio allows you to track your weight and lets you see how your weight trend changes over time. Beside your weight, it also allows you to check your body composition (fat mass, muscle mass, bone mass and water mass) which gives you a better idea of your level of fitness.

Make sure you follow the recommendations below to get accurate and representative weight measurements:

- Make sure you always weigh yourself around the same time to improve the consistency of your measurements.
- Wait five seconds before weighing yourself if you have just moved your scale.

### Weighing yourself

Thanks to the Position Control™ technology, getting an accurate weight measurement has never been easier. If your weight is not properly distributed on your Body Cardio, arrows are displayed on the scale to indicate in which direction you should lean to stabilize your weight.



If several users have a similar weight, the following screen can be displayed:

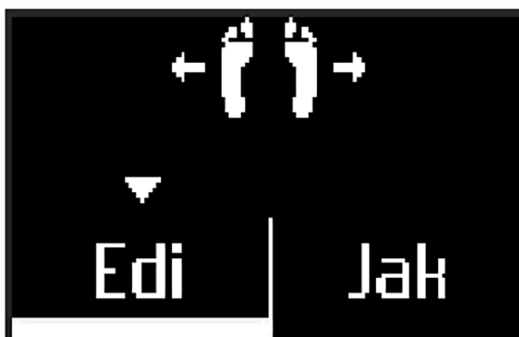

Simply lean left or right to select the correct name. Your measurements will then be affected to the correct user. Make sure you return to your initial position before the heart rate measurement starts.

If you want to get information regarding your body composition as well, make sure that:

- Body composition measurements are enabled. Refer to [“Disabling body composition and heart rate measurements” on page 24](#) for more information.
- All the body composition screens are enabled. Refer to [“Changing the screen order” on page 22](#) for more information.
- You step on the scale barefoot.
- You stay as still as possible during the measurement.
- You are recognized by your Body Cardio, with your name appearing on the screen display.

## Retrieving your weight data

As soon as you weigh yourself, your weight is displayed on the display of your scale. If you’ve activated the Weight Trend screen, you’ll also see a graph showing your eight last measurements as well as the difference between the latest measurement and the previous one. Refer to [“Changing the screen order” on page 22](#) for more information.

To see detailed graphs about your weight and body composition, and see your full history, you have to check your data on the Health Mate app.

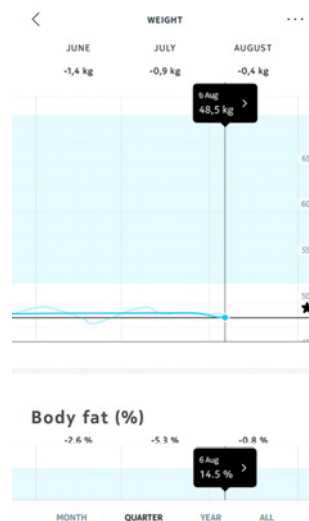

You can access your graphs:

- By tapping the Weight widget on your Dashboard.
- By tapping any weight measurement item in your Timeline.

Once you’re viewing the weight graph, you can view your body composition graphs and your BMI graph.

## Changing your weight goal

To change your weight goal, perform the following steps:

1. Open the Health Mate app.
2. Select a weight measurement in the Timeline.



3. Tap the three dots at the top right of the screen.

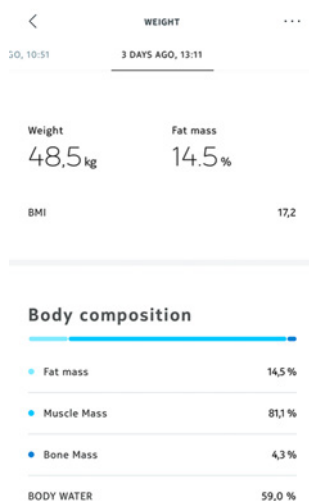

4. Tap **Set your target weight**.

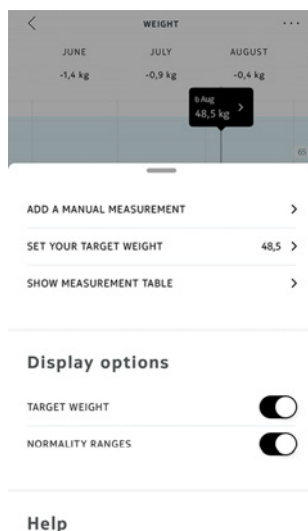

5. Tap and slide up or down to select your target weight.

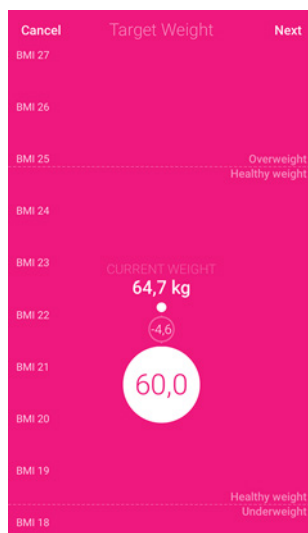

6. Tap **Next**.

7. Tap and slide up or down to select the pace at which you want to achieve your weight goal.

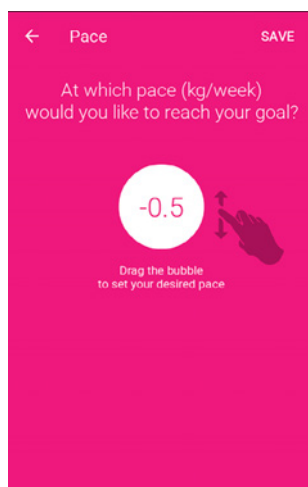

8. Tap **OK**.

## Retrieving unknown measurements

If your Body Cardio doesn't recognize you when you weigh in, your weight measurements will be listed as unknown measurements. To assign them to a user, perform the following steps:

1. Open the Health Mate app.
2. Go to **Devices**.

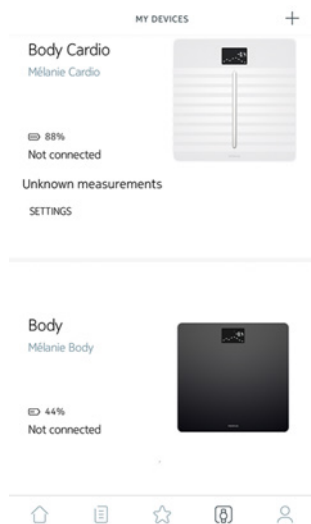

3. Select the **Unknown measurement**.

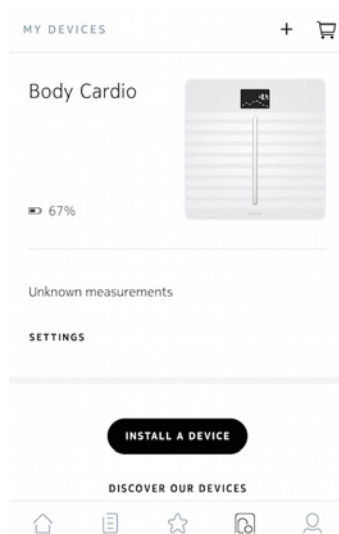

4. Tap the user you want to assign the measurement to.



Your measurements are now assigned to the correct user. Your Body Cardio will also be able to automatically assign your measurements the next time you weigh in.



## Setting reminders

The Health Mate app allows you to set reminders to make sure you weigh yourself regularly. To do so, perform the following steps:

1. Open the Health Mate app.
2. Go to **Profile**.
3. Tap **Add**.

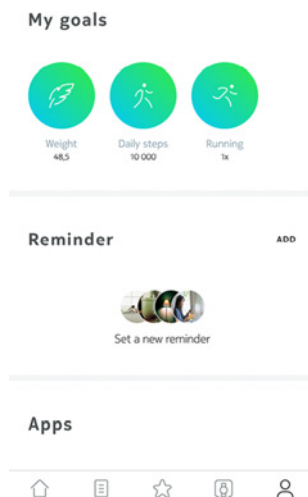

4. Select the type of reminder you want to set.

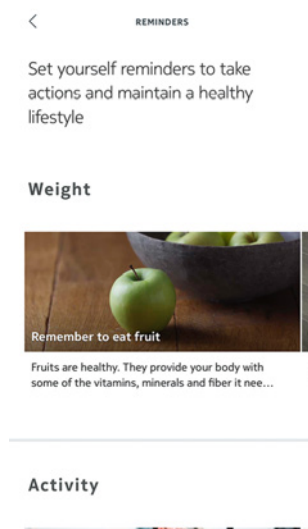

5. Select the time and recurrence of the reminder.

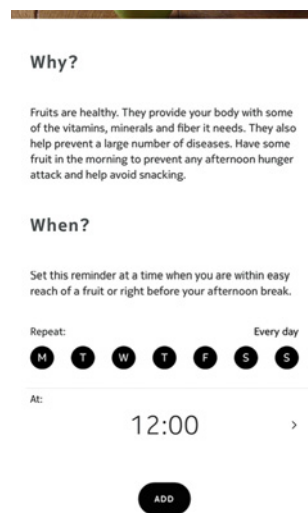

6. Tap **Add**.

## Tracking your heart rate

### Overview

**This product is not a medical device and should not be used to diagnose, treat, cure, or prevent any medical conditions.**

The Body Cardio allows you to track your heart rate and lets you see how it changes over time.

If you want to get heart rate measurements, make sure that:

- Heart rate measurements are enabled. Refer to [“Disabling body composition and heart rate measurements” on page 24](#) for more information.
- The Heart Rate screen is enabled. Refer to [“Changing the screen order” on page 22](#) for more information.
- You step on the scale barefoot.
- You stay as still as possible during the measurement.

### Retrieving your heart rate measurements

As soon as your heart rate is measured, it is displayed on the display of your scale.

To see your heart rate measurements and see your full history, you have to check your data on the Health Mate app.

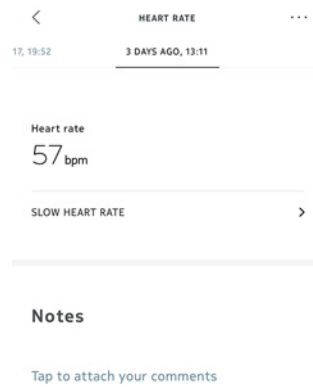

You can access your heart rate measurements by tapping any heart rate measurement item in your Timeline.

## Tracking your Pulse Wave Velocity

### Overview

**This product is not a medical device and should not be used to diagnose, treat, cure, or prevent any medical conditions.**

With every heartbeat, your heart induces a wave along the aorta and arterial tree, which leads to changes in blood volume within your vessels, making them expand and contract accordingly. Your Pulse Wave Velocity indicates the propagation speed of this wave along the arteries. It is a key indicator of your cardiovascular health.

The Body Cardio allows you to track your Pulse Wave Velocity and lets you see how it changes over time.

If you want to get Pulse Wave Velocity measurements, make sure that:

- Heart rate measurements are enabled. Refer to [“Disabling body composition and heart rate measurements” on page 24](#) for more information.
- The Heart Rate screen is enabled. Refer to [“Changing the screen order” on page 22](#) for more information.
- You step on the scale barefoot.
- You stay as still as possible during the measurement.
- Your feet are centered on the scale, and in contact with all the stripes on the surface of the scale. Ideally, your heels should be on the second stripe from the bottom.
- You take the measurement before drinking coffee or having a cigarette. Ideally, you should wait at least three hours after drinking or eating anything to take the measurement.

## Retrieving your Pulse Wave Velocity measurements

Your Pulse Wave Velocity measurements are displayed on the screen of your scale and in the app.

To see detailed graphs about your Pulse Wave Velocity and see your full history, you have to check your data on the Health Mate app.

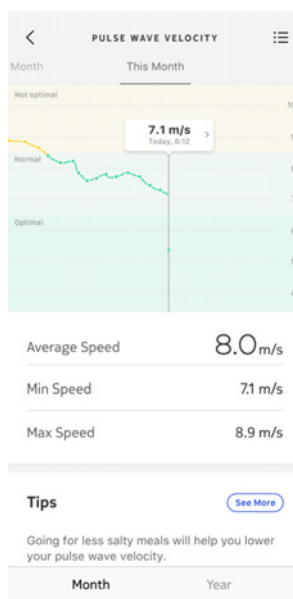

You can access your graphs by tapping any Pulse Wave Velocity measurement item in your Timeline. Click [here](#) for more information on normal ranges for this measurement.

Note that after installing your Body Cardio, you will need five valid measurements before you can access the Pulse Wave Velocity graph. These measurements are required to calibrate Pulse Wave Velocity measurement on your scale. You will receive a Timeline item every time you get a valid measurement, and a final one once you can access the graph.



## Checking the weather

### Overview

You can check the local weather forecast for the day directly on your Body Cardio if the following conditions are met:

- Your Body Cardio is set up in Wi-Fi. Refer to [“Changing the configuration of your Body Cardio” on page 18](#) for more information on how to switch to a Wi-Fi configuration.
- The Weather screen is enabled. Refer to [“Changing the screen order” on page 22](#) for more information.

### Retrieving weather information

All you have to do to retrieve weather information on your Body Cardio is to step on the scale and wait for the Weather screen to be displayed.

The Weather screen provides you with information about the average weather and temperature for the morning (between 6:00 AM and 12:00 PM) and for the afternoon (between 12:00 PM and 9:00 PM).



If you weigh yourself in the morning, the data of the day is displayed. If you weigh after 7:00 PM, the data of the next day is displayed.

## Using Baby mode

Baby mode allows you to find out the weight of your baby by weighing yourself on the scale while holding your baby. To use this mode, you must create a profile for your baby in the Health Mate app. Then enter the height and weight of your baby and weigh yourself while holding your baby in your arms. The weight of your baby will be automatically detected by the scale.

**Important:** your baby must weigh between 7 and 33 lbs (3 and 15 kg) to be detected by the scale. As Baby mode is enabled by default on the Body Cardio, you do not need to enable it in the Health Mate app.

Follow the steps below to use Baby mode:

1. Create a profile for your baby in the Health Mate app.
2. Enter the height and weight of your baby.
3. Weigh yourself on your own.

Your weight will be displayed on the screen of the Body Cardio.

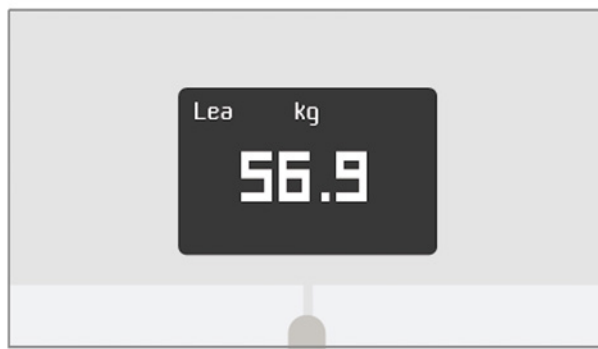

4. Weigh yourself with your baby (within 5 minutes of first weighing yourself). The scale will display your weight plus your baby's weight, followed by the weight of your baby on its own.

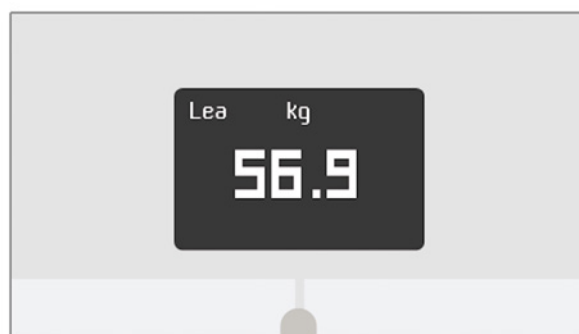
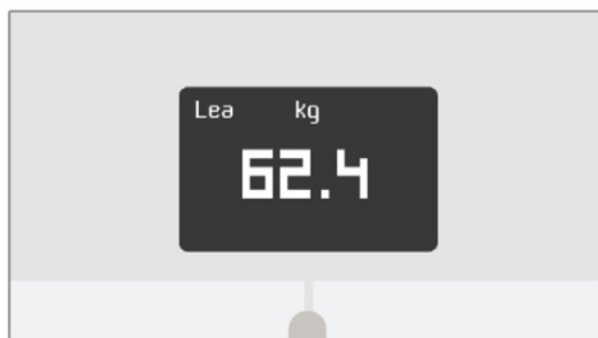

For best results, we recommend you to weigh yourself when your baby is calm.

**Note:** you can use Baby mode for several members of your family. For example, you may wish to add a profile for your baby to your account or create a separate account for your baby. Please note that you can add up to 8 users to your Withings account.

## Using Pregnancy mode

Pregnancy mode provides an enriched Health Mate experience for pregnant women, offering advice, tips, and easy weight tracking throughout pregnancy.

Pregnant women will receive the following information on a weekly basis in their Health Mate Timeline:

- an overview of the week with the current stage of pregnancy and cumulative weight gain, along with how it compares with your personalized recommendations.
- health-related and obstetrician-reviewed information relevant to the current week of pregnancy.

### Activating Pregnancy Mode

Pregnancy Mode can be activated by any woman at any time during pregnancy. To do so, perform the following steps:

1. Open the Health Mate app.
2. Go to **Wellness Programs**.
3. Tap **Learn more**.

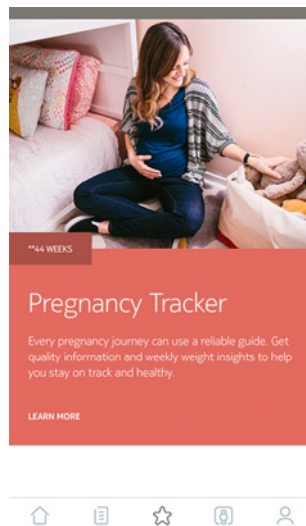



4. Tap **Join**.



### Pregnancy Tracker

Every pregnancy journey can use a reliable guide. Get quality information and weekly weight insights to help you stay on track and healthy.

#### \*\*ABOUT THE PROGRAM

Big changes are underway! The Baby on Board program offers well-timed advice, tips, and easy weight tracking throughout your entire pregnancy journey. Each week you'll get obstetrician-reviewed

FAMILY  
\*\*44 WEEKS

**\*\*JOIN**

# Linking your account to MyFitnessPal

---

## Overview

When you monitor your weight, it can also be useful to monitor your calorie intake with apps such as MyFitnessPal to help you reach your weight goal.

Once you link both accounts, your Withings account will be able to retrieve your daily calorie intake from MyFitnessPal. You can then check the MyFitnessPal widget from your Dashboard to see your calorie balance.

MyFitnessPal can also retrieve information from your Withings account: your weight and your calorie outtake.

Your calorie outtake is based on any activity data coming from a Withings activity tracker or the in-app tracking feature of the Health Mate app. Note that tracking your activity can be a great way to help you achieve your weight goal.

## Connecting to MyFitnessPal

To connect your Withings account to your MyFitnessPal account, perform the following steps:

1. Open the Health Mate app.
2. Tap **Profile**.
3. Tap **MyFitnessPal**.

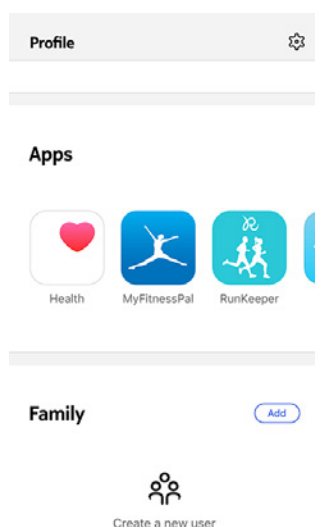

4. Tap **Open**.

5. Log in to your MyFitnessPal account.

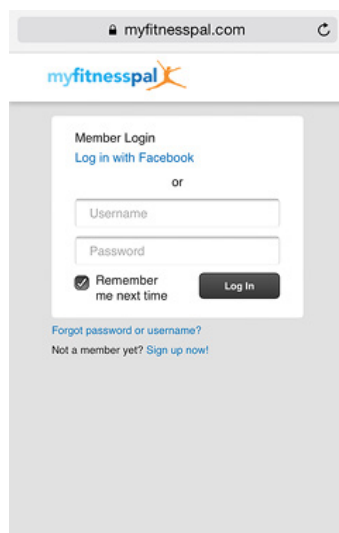

You can unlink your MyFitnessPal account and your Withings account anytime you want from your Profile.

# Syncing your data

---

Data from your Body Cardio is automatically synced, without any action required on your part. Your weight data is synced with the Health Mate app within a few minutes after you weigh in. Your pulse wave velocity, heart rate and body composition data is also synced at this time.

Note that if you sync your data in Bluetooth, it is necessary that a paired device is within range of the scale. The Health Mate app also needs to be running on your device.

# Dissociating your Body Cardio

**All data that wasn't synced before dissociating your Body Cardio will be lost permanently.**

Dissociating your Body Cardio allows you to remove it from your account.

**Dissociating your Body Cardio will not remove any of the data that was synced from the Health Mate app.**

To dissociate your Body Cardio, perform the following steps:

1. Open the Health Mate app.
2. Go to **Devices**.
3. Tap **Body Cardio**.

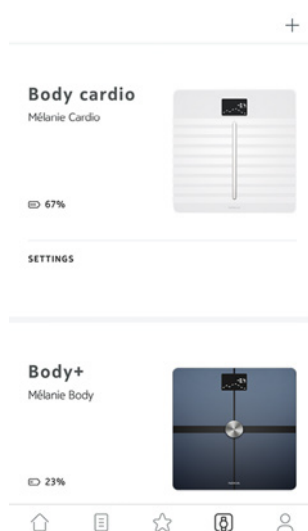

4. Tap **Dissociate this product**.

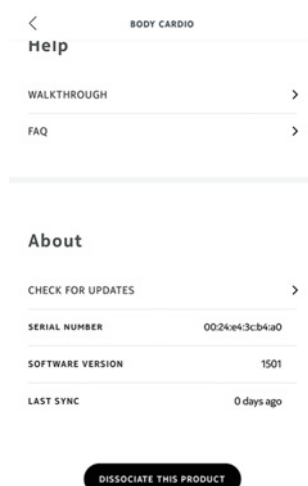

5. Tap **Remove from my account**.

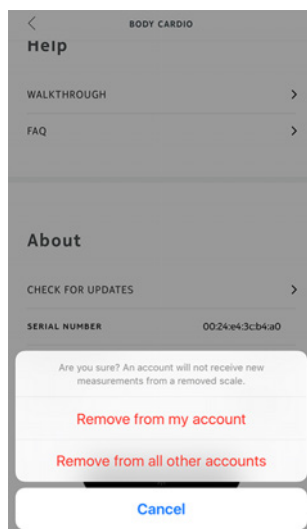

6. Perform a factory reset of your Body Cardio. Refer to [“Performing a factory reset of your Body Cardio” on page 47](#) for more information.

# Performing a factory reset of your Body Cardio

---

**All data that wasn't synced before factory resetting your Body Cardio will be lost permanently.**

Factory resetting your Body Cardio allows you to delete the data stored on it. Factory resetting completes the dissociation process.

**Factory resetting your Body Cardio will not remove any of the data from the Health Mate app.**

1. Go to the Bluetooth settings of your device and “forget” your Body Cardio from the list of Bluetooth devices.
2. Press the button on the side of the scale for 15 seconds until the display turns off.
3. When “Hello” appears on the display of your scale, press and hold the button on the side of the scale until the factory reset gauge fills.  
The scale's screen will display the word “Factory”, confirming the reset.

At this time, you can start the installation process for the Body Cardio. Refer to [“Setting up the Body Cardio” on page 8](#) for more information.

# Cleaning and maintenance

---

## Cleaning your Body Cardio

You can clean your Body Cardio using a cloth dampened with water. If water is not enough to clean it, you can also use crystal vinegar.

**The use of any detergents or cleaners may cause irreversible damage to the coating that protects the electrodes used to measure your body composition.**

## Charging the battery

You can check the battery level of your Body Cardio by going to **Devices** > **Body Cardio** from the Health Mate app. If the battery level reaches 5% or less, we advise that you charge the battery. To do so, connect your Body Cardio to a power source using the USB cable provided with the scale.

Charging the battery can take up to five hours. You can press the button on the side of the scale while it's charging to check the battery level.

Note that you shouldn't use your Body Cardio while it is charging.

Your Body Cardio has an approximate battery life of 18 months.

## Updating your Body Cardio

We regularly offer updates so that you can benefit from the latest features we add to our products. When new internal software is available, it is automatically installed without any prompt from the Health Mate app if your scale is installed in Wi-Fi.

However, you can check if updates are available and force their installation whenever you want. To do so, perform the following steps:

1. Open Health Mate app.
2. Go to **Devices**.



3. Tap **Body Cardio**.

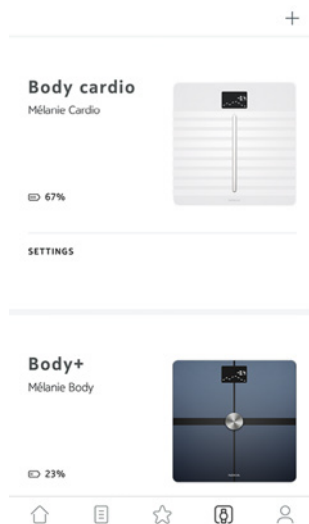

4. Tap **Check for updates**.

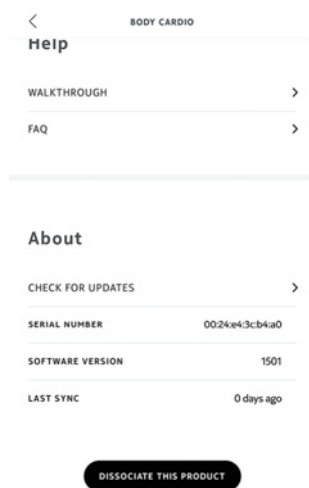

5. Press and hold the side button for three seconds and tap **Next**.

6. Tap **Upgrade**.

7. Tap **Close** when the upgrade is complete.

**Note:** You can check which firmware version your Body Cardio uses in **Devices > Body Cardio**.

# Technology description

---

## Weight

Your weight is measured thanks to four weight sensors placed below the surface of your Body Cardio.

## Body composition

Your body composition (fat mass and water percentage, muscle mass, and bone mass) is measured by bioelectrical impedance analysis thanks to electrodes placed below the surface of your Body Cardio. These electrodes send a small current that goes through your body, and then analyse the way your body reacts to measure these metrics.

## Heart rate

Your Body Cardio uses patent-pending heart rate measurement technology to measure your heart rate while you weigh in.

## Pulse Wave Velocity

Your Body Cardio uses patent-pending pulse wave velocity measurement technology to measure your pulse wave velocity while you weigh in.

# Specifications

---

## Body Cardio

- Length: 327 mm (12.8")
- Width: 327 mm (12.8")
- Depth: 18 mm (0.7")
- Weight: 2.6 kg (5.7lbs)
- Weight range: 5 kg - 180 kg (9 lbs - 396 lbs)
- Weight units: kg, lb, stlb
- Precision: 100 g (0.2 lbs)

## Display

- 6.1 cm x 4.1 cm (2.4" x 1.6")
- 128 x 64 pixels
- Backlighting

## Connectivity

- Wi-Fi 802.11 b/g/n (2,4 GHz only)
- Bluetooth / Bluetooth Low Energy (Bluetooth Smart Ready)

## Sensors

- 4 weight sensors
- Position Control™ technology

## Metrics

- Weight
- Fat mass (%) - standard and athlete mode
- Muscle mass (kg)
- Bone mass (kg)
- Water mass (%)
- Heart rate
- Pulse wave velocity

## Batteries

- Li-ion battery
- Average battery life of 18 months

## Features

- Automatic user recognition
- Weather forecast

## Compatible Devices

- iPhone 4s (or higher)
- iPod Touch 4th Gen (or higher)
- iPad 2nd Gen (or higher)
- Android device running Android 5.0 (or higher)

## Compatible OS

- iOS 8.0 (or higher)
- Android 5.0 (or higher)

# User guide copyright

---

This User Guide is protected by Intellectual Property laws and copyright. Any reproduction, modification, representation, and/or publication without Withings prior approval is strictly prohibited. You may print this User Guide for your personal use exclusively.

For any questions, please contact Withings at: <https://support.withings.com/hc/en-us/requests/new>.

## Legal notice

---

**This product is not a medical device and should not be used to diagnose or treat any medical condition.**

**People wearing a pacemaker or any other internal medical device should disable the body composition measurement. Refer to “[Disabling body composition and heart rate measurements](#)” on page 24 for more information.**

## Personal data

- Make sure you have read our privacy policy, which you can find on our [Privacy Policy](#).
- Make sure your Withings account password is secure enough to restrict access to your account. It should be at least eight-character long, have mixed case, and use a combination of alphanumeric and special characters.
- We recommend that you protect access to the Health Mate app with an additional passcode and/or Touch ID. You can do so from the app by going to **Settings** in the app and activating **Touch ID and Passcode**.
- We recommend that you export your data on a regular basis to local storage on your home computer. You can do so from the Health Mate [web interface](#) by clicking your **Profile picture** > **Settings** > **User Preference** > **Download my data**.

# Safety instructions

---

## Use and storage

- Use the product at temperatures between 5°C and 35°C (41°F and 95°F) with a relative humidity between 30% and 80%.
- Product may be stored in a clean location between -10°C and 50°C (14°F and 122°F) when it is not in use, with a relative humidity between 10% and 90%.
- This product is not a toy. Do not allow children to play with it.
- This device is designed for indoor use only.
- Do not allow the device to come in contact with liquids.
- Do not use any detergents or cleaners to clean the scale. They may cause irreversible damage to the coating that protects the electrodes used to measure your body composition.
- Do not use your Body Cardio in a place that is too humid as it can affect the battery.

## Service and maintenance

- Do not attempt to repair or modify your Body Cardio yourself. Service and maintenance not described in this User Guide should be performed by professional technicians.
- If you have any issues, feel free to contact customer service at: <https://support.withings.com/hc/en-us/requests/new>.

# Document release overview

---

Release date		Modifications
June 2016	v1.0	First release
December 2016	v2.0	Update of: “Legal notice” on page 53 ““Disabling body composition and heart rate measurements” on page 24
August 2017	v3.0	Nokia graphic chart
September 2018	v4.0	Withings graphic chart
April 2019	v5.0	Pulse Wave Velocity reactivation Update of: “Tracking your Pulse Wave Velocity” on page 35 “Pulse Wave Velocity” on page 50

**The screenshots in this manual are used for explanatory purposes. Your actual screens may differ from the screenshots in this manual.**

# Warranty

---

## Withings One (1) Year Limited Warranty - Body Cardio

Withings warrants the Withings branded hardware product (“Body Cardio”) against defects in materials and workmanship when used normally in accordance with Withings’ published guidelines for a period of ONE (1) YEAR from the date of original retail purchase by the end-user purchaser (“Warranty Period”). Withings’s published guidelines include but are not limited to information contained in technical specifications, safety instructions, or quick start guide. Withings does not warrant that the operation of the Body Cardio will be uninterrupted or error-free. Withings is not responsible for damage arising from failure to follow instructions relating to the Body Cardio’s use.

### **The warranty does not extend to:**

- Any damage to the device resulting from abnormal or abusive use, negligence or lack of care, or accidental damage (such as dents).
- Indirect damages of any kind.



# Regulatory Statements

---

FCC ID: XNAWBS04

This device complies with Part 15 of the FCC Rules.

Operation is subject to the following two conditions: (1) This device may not cause harmful interference, and (2) This device must accept any interference received, including interference that may cause undesired operation.

This device complies with the R&TTE Directive. A copy of the EU Declaration of Conformity is available online at <https://www.withings.com/fr/en/compliance>