

GLX+Q 1 1COM 16A 2M AST IR

GLX+Q 1 2COM 16A 2M AST IR

Astronomical twilight switches: User Manual



Index

- **Safety warnings** pag. 3
- **Technical characteristics** pag. 3
- **Dimensions** pag. 4
- **Connection diagrams** pag. 4
- **Display and keypad description** pag. 5
- **Installation** pag. 6
 - Setting the language pag. 7
 - Setting the date format pag. 7
 - Setting the date pag. 7
 - Setting the time pag. 8
 - Setting the coordinates/province capital pag. 8
- **Manual operation** pag. 10
 - Switching on/off manually pag. 10
 - Switch lock pag. 10
- **Pre-set programs** pag. 10
 - P1 program pag. 10
 - P2 program pag. 10
 - P3 program pag. 11
 - P4 program pag. 11
 - P5 program pag. 11
 - P6 program pag. 11
- **Automatic operation** pag. 12
 - 1. NIGHT PROGRAM C1 menu pag. 12
 - 1.1 NIGHT C1 display pag. 12
 - 1.2 Change NIGHT C1 pag. 13
 - 2. Menu HOLIDAY PROGRAM pag. 14
 - 2.1 Creating a HOLIDAY program pag. 14
 - 2.2 Checking a program pag. 15
 - 2.2.1 Displaying a program HOLIDAY pag. 15
 - 2.2.2 Changing a program HOLIDAY pag. 15
 - 2.2.3 Deleting a program HOLIDAY pag. 16
 - 2.3 Deleting a program HOLIDAY pag. 16
 - 3. Programs reset pag. 16
- **Settings menu** pag. 17
 - LANGUAGE menu pag. 17
 - DATE menu pag. 17
 - TIME menu pag. 17
 - CET / DST CHANGE menu pag. 18
 - POSITION menu pag. 19
 - CORRECTION menu pag. 20
 - PIN menu pag. 20
 - SETTING RESET menu pag. 21
- **Hour meter menu** pag. 22
- **Reset menu** pag. 22
- **IR Interface** pag. 23
 - Copy function pag. 23
 - Paste function pag. 24
- **Battery replacement** pag. 25
- **Reference standards** pag. 25

Astronomical twilight switches



- Instrument to manage electric utilities between the hours of sunset and sunrise, which are automatically calculated by the instrument based on the geographical coordinates inserted.
- Two versions
 - GLX+Q 1 1COM 16A 2M AST IR with 1 relay and P1 fixed programming
 - GLX+Q 1 2COM 16A 2M AST IR with 2 relays: relay 1 programmable with the possibility to choose between 6 pre-set programs, relay 2 with P1 fixed programming

- Large display with text guide to facilitate programming
- Seable cover and possibility to lock keypad through password

Astronomical twilight switches



- IR remote control (available as an accessory) for transferring programmes from and to the instrument



- Possibility of a programmes archive (up to 126) always available

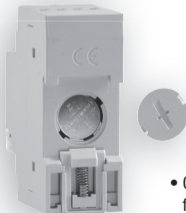

- Cover on the back of the instrument for replacing the battery

SAFETY WARNINGS

- 1) The instrument must be installed and activated by qualified personnel, following the connection diagrams provided in this manual scrupulously.**
- 2) After installation, it must be made impossible to access the terminals without specific tools**
- 3) Before accessing the connection terminals, verify that the leads are not live**
- 4) Do not connect or power the instrument if any part of it is damaged**
- 5) The instrument must be installed and activated in compliance with current electric systems standards.**
- 6) Do not use the instrument for purposes other than those indicated**

Code	Model	Description
687454	GLX+Q 1 1COM 16A 2M AST IR	Astronomical twilight switch 1 relay
687455	GLX+Q 1 2COM 16A 2M AST IR	Astronomical twilight switch 2 relay

TECHNICAL CHARACTERISTICS

- Power supply: 230Vac \pm 10% 50/60Hz
- Absorption: 8VA (2W)
- Replaceable battery
- Output:
 - GLX+Q 1 1COM 16A 2M AST IR: 1 relay with changeover contact 16(10)A / 250Vac
 - GLX+Q 1 2COM 16A 2M AST IR: 2 relays with changeover contact 16(10)A / 250Vac
- Type of action: 1B
- Programs available (only for GLX+Q 1 2COM 16A 2M AST IR)
 - 6 pre-set programs
 - 4 periods + 20 holiday days
- Backlit LCD display
- Integrated IR interface with 0.5m capacity with direct sun light (2m when dark)
- IR transmission frequency: 31.25kHz
- Software class: A
- Mounting: DIN rail to backplane
- Container: 2 DIN modules
- Operating temperature: $-20^{\circ}\text{C} \div +40^{\circ}\text{C}$
- Storage temperature: $-10^{\circ}\text{C} \div +70^{\circ}\text{C}$
- Pollution level: 2
- Rated impulse voltage: 4kV
- Degree of protection: IP20 at the terminals

DIMENSIONS

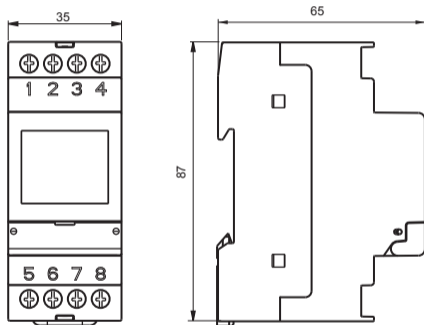

CONNECTION DIAGRAMS

GLX+Q 1 1COM 16A 2M AST IR

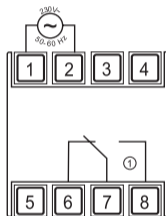

GLX+Q 1 2COM 16A 2M AST IR

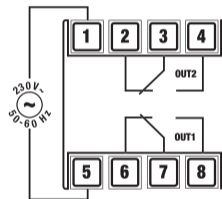

DISPLAY AND KEYPAD DESCRIPTION

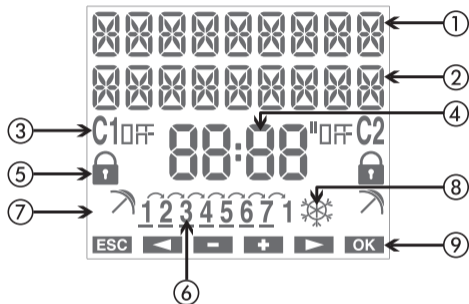

- ⑦ Field **“holiday program”**
- ⑧ Field **“CET/DST”**
- ⑨ Field **“key functions”**



- Key **“←”**: menu/esc/check battery activation
- Key **“Ok”**: confirm value/activation IR transmission
- Key **“C1”**: decreases the value/menu back/
switching relay 1/lock relay 1
- Key **“C2”**: increases the value/menu forward
switching relay 2/lock relay 2
- Key **“R”**: resets settings

- ① Field **“text1 / day”**
- ② Field **“text2 / date”**
- ③ Field **“relay status”**
- ④ Field **“time”**
- ⑤ Field **“lock”** (relay switching lock)
- ⑥ Field **“day of the week”**

INSTALLATION

- The instrument is supplied with the battery not installed to prevent useless consumption. Remove the battery from its package and insert it in the housing on the back of the instrument **so that the (+) pole is visible as shown in the “Battery replacement” box**. Then secure the cover, turning it clockwise.

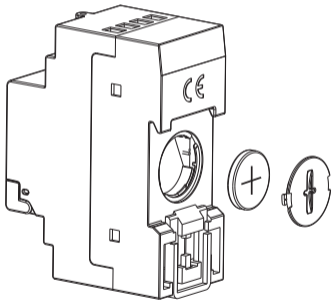

- Connect the load and the power supply as illustrated in the “Connection diagrams” chapter.

- Use a pointed object to press the “R” key to reset it. The display segments will turn on for a few seconds, then the instrument will switch to IR reception mode.

Note: in the case of a mains power failure, IR reception is not activated.

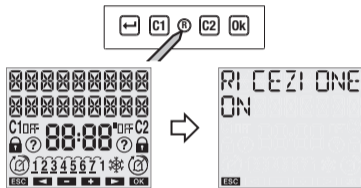

- Press the “←” key to exit the IR reception mode (if you want to transfer programs from the remote control, see the “IR Interface” pag. 23)
- At this point, the parameters required for correct instrument operation can be entered:
 - language, date format, date, time, geographical coordinates and any corrections (or simply the province for Italy).

Setting the language

5 languages are available:
Italian, English, Spanish, French, German.

- Select the language with **"C1"** and **"C2"**.
- Confirm with **"Ok"**.

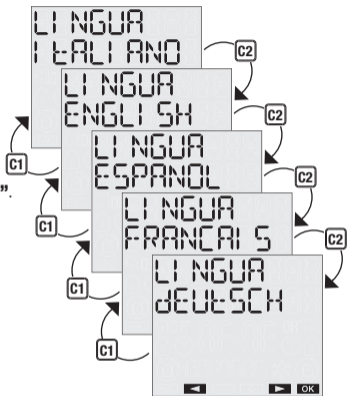

Setting the date format

It is possible to select between the dd-mm-aa and yy-mm-dd formats.

- Select the format with **"C1"** and **"C2"**.
- Confirm with **"Ok"**.

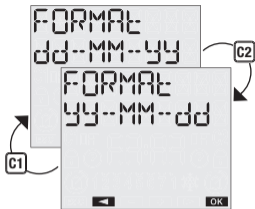

Setting the date

The parameter (year, month, day) being changed will flash.

- Select the desired value with **"C1"** and **"C2"**.
- Press **"Ok"** to confirm and continue with the next parameter

The insertion sequence is year → month → day

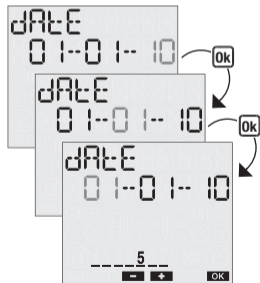

When the day is being entered, the display will show a bar with the corresponding day of the week (1 → Monday, 7 → Sunday).

Setting the time

The parameter (hours, minutes) being changed will flash.

- Select the desired value with “C1” and “C2”.
- Press “OK” to confirm and continue with the next parameter

The insertion sequence is hours → minutes

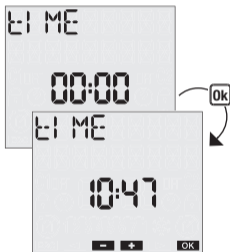

Setting the coordinates/province capital

By setting the geographical coordinates, the instrument is able to automatically calculate the sunrise and sunset times for each day during the year. The menu changes depending on the set language:

- if Italian is selected, then only the province where the instrument is installed must be entered (the display will show the province abbreviations followed by the full name, possibly shortened to six characters).

- Select the province with “C1” and “C2”.
- Press “OK” to confirm

CAPOLUOGO
AG--AGRIG

CAPOLUOGO
AL--ALESSA

CAPOLUOGO
AN--ANCONA

CAPOLUOGO
AO--AOSTA

- if a language other than Italian is selected, the following parameters must be entered:

- latitude
- longitude
- the time zone (a time zone is suggested based on the latitude and longitude values; this value may be changed using the "C1" and "C2" keys)
- sunrise and sunset time corrections (in this phase do not enter a correction, leave the two values at 0 and press "Ok")

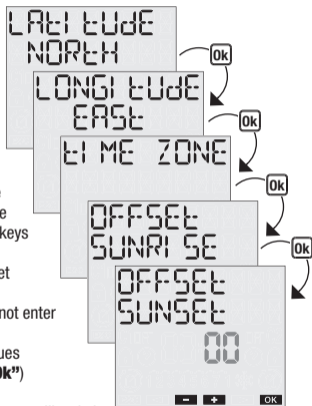

At this point, the instrument will switch to the normal operating status (main

page). The display will show the date, time, relay status, day of the week (in letters on the top row, in numbers at the bottom) and the CET / DST symbol.



Main page

Note: if the instrument is not powered by the mains, instead of the day the following message will appear on the top row NO SUPPLY.

In this condition backlighting is not active and the relay will remain off.

MANUAL OPERATION

Switching on/off manually

Press the “C1” (“C2”) key briefly to switch the output relay 1 (relay 2, if present).

The status that is reached will be maintained until the next program event.

Switch lock

Activating the lock function, all switches are ignored. The relay remains in the status in which it was found when the lock was set.

- Press and hold “C1” (“C2”) for 3 seconds to activate/deactivate the relay 1 (relay 2, if present)

If the function is active, the following symbol will appear .

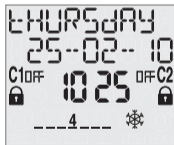

PRE-SET PROGRAMS (only for GLX+Q 1 2COM 16A 2M AST IR)

GLX+Q 1 2COM 16A 2M AST IS is equipped with 6 pre-set programs that allow you to program the instrument's night behaviour.

P1 program

This program sets switch on at sunset and switch off at dawn.



P2 program

This program keeps the relay in the off position throughout the night.



P3 program

This program sets switch on at sunset and switch off at dawn, with a night-time interruption in which the relay is temporarily in the off position.

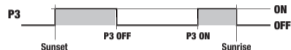

P4 program

This program sets switch on at sunset and switch off during the night, at a programmable time (before dawn).

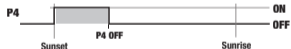

P5 program

This program sets switch on at a programmable time (after sunset) and switch off at dawn.

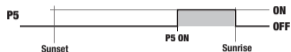

P6 program

This program sets an on impulse during the night with programmable initial time and duration of the impulse. The impulse's maximum duration is 59 seconds.

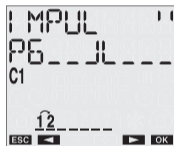
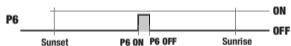

Note: the relay 2 has a program set to P1 (it cannot be modified). The selection of the night-time behaviour is therefore only limited to relay 1.

Note: the dawn and sunset times are automatically calculated by the instrument on the basis of the astronomical coordinates entered and of any time adjustments (see chapter "Settings").

AUTOMATIC OPERATION

The default settings are the following:

- GLX+Q 1 1COM 16A 2M AST IR:
 - Program P1 (unchangeable)
- GLX+Q 1 2COM 16A 2M AST IR:
 - program P1 on relay 1
 - program P1 on relay 2 (unchangeable)

The “NIGHT PROGRAM C1” menu allows you to program the behaviour of relay 1, by assigning a different program for each day of the week.



The “holiday” menu allows you to enter individual days or holiday periods during which all the set programmes shall not be carried out and the relay shall be in the off position.



1. NIGHT PROGRAM C1 menu

With this menu it is possible to view and change the programs set on relay 1.

1.1 NIGHT C1 display

From the normal operating status:

- Press key “←”
- Select PROGRAM with “C1” and “C2” and confirm with “OK”
- Select NIGHT PROGRAM C1 with “C1” and “C2” and confirm with “OK”
- The display shows the set program for the first night of the week (in the P1 example in the night between days 1 and 2, i.e. between Monday and Tuesday). Press “C1” and “C2” to cycle through the nights of the week and display which program is set for each night



Note: the display of the P3 program is divided into two screen shots, the first one showing the switch off time and the second time the switch back on time.

To go from one screen to the other, press keys "C1" and "C2".

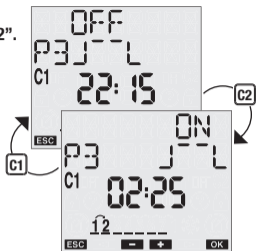

1.2 Change NIGHT C1

Should you wish to change the program assigned to a specific day of the week, follow these steps.

From the day display menu:

- Press **"Ok"** to enter into modification
- The display shows the currently set program, flashing: press **"C1"** and **"C2"** to choose which program (P1... P6) to set and confirm with **"Ok"**

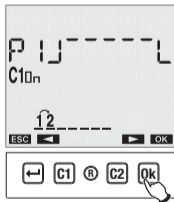

- Enter the parameters relative to the selected program:
 - P1: no parameter*
 - P2: no parameter*
 - P3: night switch off time, night switch on time*
 - P4: night switch off time*
 - P5: night switch on time*
 - P6: initial time of the impulse, duration of impulse*
- Press **"Ok"** to confirm. The display will show the words **SAVED C1** and the instrument shall enter normal operation.

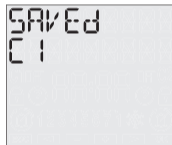

2. Menu HOLIDAY PROGRAM

2.1 Creating a HOLIDAY program ↗

From the normal operating status:

- Press “↵”
- Select PROGRAM with “C1” and “C2” and confirm with “OK”
- Select PROGRAM HOLIDAY with “C1” and “C2” and confirm with “OK”
- Select HOLIDAY NEW and confirm with “OK”
- Choose the relay onto which to carry out the programming
- Select between HOLIDAY ONE DAY (single day) or HOLIDAY PERIOD (multiple contiguous days) with “C1” and “C2”
- Enter the date (holiday day) or the holiday day interval (holiday period).

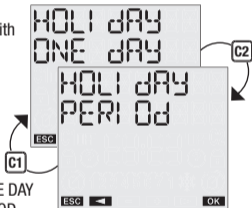

Note: the first and last date are to be considered included in the holiday period

- Press “OK” to confirm

Once the programming is confirmed, the following message will appear on the display START.

During normal operation, the possible execution of a holiday programme is signalled by the symbol ↗ in field (7) on the display.



Note: recursive function

At this point, the instrument activates the recursive function that makes it possible to program multiple holiday days in series (or holiday periods).

If you do not want to enter another holiday day (or period) press “↵” to end programming.

The correlation of the programmed holiday events is not controlled with the recursive function: the function must therefore be considered as facilitated programming.



The instrument's memory makes it possible to store up to 4 holiday periods + 20 holiday days. Once the maximum capacity is reached, an attempt to store an additional program will cause the following message to be displayed MEMORY FULL. In this case, a program stored in the memory must be deleted before entering a new one.

The message ERROR appears on the display if you try to enter a holiday period that overlaps with a period that was already entered, or if the last holiday date is before the start date.

2.2 Checking a program

This menu can be used to display, modify or delete a holiday program saved in the instrument.

2.2.1 Displaying a program HOLIDAY

From the normal operating status:

- Press "**↵**" to access the menu and select PROGRAM with "**C1**" and "**C2**"
- Confirm with "**OK**"
- Select PROGRAM HOLIDAY and press "**OK**" to confirm

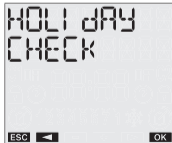

- Select HOLIDAY CHECK and press "**OK**" to confirm
- Choose the relay onto which to visualize the program holiday with "**C1**" and "**C2**" (only for GLX+Q 1 2COM 16A 2M AST IR)
- Select between HOLIDAY ONE DAY and HOLIDAY PERIOD and press "**OK**" to confirm

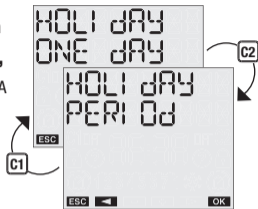

In case of HOLIDAY ONE DAY it is possible to scroll the programs using "**C1**" and "**C2**" keys. In case of HOLIDAY PERIOD the instrument shows the start day of the first holiday period, press "**C2**" to visualize the end of the period.

At this point, pressing "**OK**" it is possible to access options of modify, delete or next holiday period.

2.2.2 Changing a program HOLIDAY

A program can be changed from the program display status.

- Select the holiday program to change and press "**OK**"
- Select MODIFY with "**C1**" and "**C2**" and press "**OK**" to confirm

- At this point, new program parameters can be entered. The parameter being changed will flash. Use the keys “C1” and “C2” to set the values and press “Ok” to confirm or “↵” to exit without changes.



When done with the change, the message **SAVED** is displayed and the instrument will return to normal operation.

2.2.3 Deleting a program HOLIDAY

A program can be deleted from the program display status.

- Select the holiday program to delete and press “Ok”
- Select DELETE with “C1” and “C2” and press “Ok” to confirm or “↵” to exit without deleting.



The message **DELETE** will appear on the display and the instrument will return to normal operation.

3. Programs reset

Program reset make it possible to delete all holiday events (days and periods) saved in the instrument, in the case of GLX+Q 1 2COM 16A 2M AST IR, sets program 1 on relay 1.

From the normal operating status:

- Press “↵”
- Select PROGRAM with “C1” and “C2” and confirm with “Ok”
- Select PROGRAM RESET with “C1” and “C2” and press “Ok” to confirm
- Confirm with “Ok” or press “↵” to exit without resetting



Note: the program reset function can also be accessed from the Reset menu (see “Reset menu”) chapter.

SETTINGS MENU

This menu is used to display and change the instrument's general configuration parameters.

These are: language, date, time, automatic CET / DST, position, correction, pin reset.

From the normal operating status:

- press “←”
- select SETTINGS with “C1” and “C2”
- confirm with “Ok”.



LANGUAGE menu

The options are:
Italian, English, Spanish, French, German.

- select SETTINGS LANGUAGE with “C1” and “C2”
- confirm with “Ok”.
The currently set language will be displayed.



- press “Ok” twice to access the change mode or “←” to exit without changing
- select the language with “C1” and “C2”
- confirm with “Ok”.
- The following message will appear on the display *SAVE d.*

DATE menu

- Select SETTINGS DATE with “C1” and “C2”
- confirm with “Ok”. The current date is displayed.
- Press “Ok” twice to access the change mode or “←” to exit without changing
- select the format with “C1” and “C2” (dd-mm-yy or yy-mm-dd)
- confirm with “Ok”
- enter the year, month, day with “C1” and “C2” and press “Ok” to confirm
- The following message will appear on the display *SAVE d.*

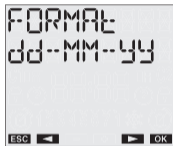

TIME menu

- Select SETTINGS TIME with “C1” and “C2”
- confirm with “Ok”. The current time is displayed
- Press “Ok” twice to access the change mode or “←” to exit without changing

- enter the time, minutes with **"C1"** and **"C2"** and press **"Ok"** to confirm
- The following message will appear on the display **SAVEd**.



CET / DST CHANGE menu

The instrument makes it possible to automatically manage the CET/DST change and vice vers.

To activate/deactivate the function:

- select SETTINGS DST with **"C1"** and **"C2"**
- confirm with **"Ok"**. The current status will appear on the display (AUTO OFF or AUTO ON)
- press **"Ok"** twice to access the change mode
- select SET AUTO ON or SET AUTO OFF with **"C1"** and **"C2"**
- press **"Ok"** to confirm.

If the function is deactivated (AUTO OFF) then the following message



SAVEd will appear on the display and the instrument will return to the main page; if the function is active, press **"C2"** to view/change the DST → CET change.

- Press **"Ok"** twice to change the parameters or **"C2"** again to display the parameters relative to the DST → CET change

The following parameters must be entered (for both changes):

- week of the change (1ST first, 2ND second, 3RD third, 4TH fourth, LAST last of the month)
- month of the change
- day of the week (Monday, Tuesday, ...)
- time of the change

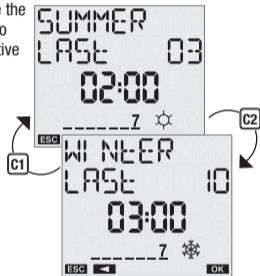

When all parameters are set, press **"←"** to exit.

The default values for the time change are:

- winter → summer change: last Sunday in March, 2:00 am
- summer → winter change: last Sunday in October 3:00 am

During normal operation, the symbol ❄️ will appear on the display during the CET period (winter) and the symbol ☀️ will appear during the DST period (summer).

POSITION menu

This menu is used to change the geographical coordinates (latitude, longitude, time zone) that were set during the installation phase.

To change a parameter:

- Select SETTINGS POSITION with "C1" and "C2" and press "Ok" to confirm

- If Italian is set as the language, it is possible to select to change only the province or make a change using the geographical coordinates:

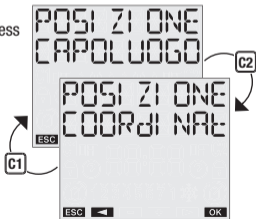

- if you want to change the province, select CAPITAL POSITION and press "Ok". The currently set province will be displayed: press "Ok" to access the change mode and select the new province with "C1" and "C2" and confirm with "Ok". At this point the message S.R.V. E.d will be displayed to indicate the change that was made.

- Select the parameter to change from among latitude, longitude or time zone and press "Ok" to confirm

- The parameter value is displayed: press "Ok" to access the change mode

- Set the new value with "C1" and "C2" and press "Ok" to confirm.

- The following message will appear on the display S.R.V. E.d.

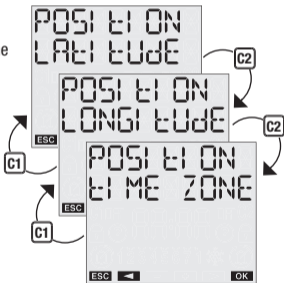

CORRECTION menu

This function is used to change the sunrise and sunset time that is automatically calculated by the system (maximum correction ± 120 minutes).

To display the calculated sunrise and sunset times:

- From the main page, press **"Ok"**.
The currently calculated sunrise and sunset times will be displayed in sequence.

To change the sunrise and sunset time:

- Select SETTINGS CORRECTION and confirm with **"Ok"**
- Select the time to correct **"C1"** and **"C2"** l'orario da correggere (sunrise or sunset)
- Confirm with **"Ok"**. The currently set correction is displayed. Press **"Ok"** again to change the value.
- Set the correction with **"C1"** and **"C2"** and press **"Ok"** to confirm (use negative values to advance the event, positive values to delay the event).

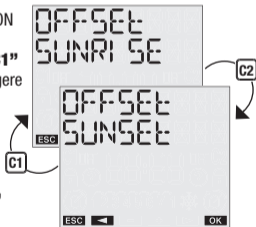

- The message $\Sigma \Delta$ appears on the display to indicate the change that was made

At this point, pressing **"Ok"** on the main page, the corrected sunrise and sunset times are displayed again.

PIN menu

A protection code can be set to prevent anyone from using the instrument.

The PIN code is a 4 digit number that has values between 1 and 4.

To set the pin code:

- select SETTINGS PIN with the keys **"C1"** and **"C2"**
- confirm with **"Ok"**
- the four digits that make up the current PIN code are displayed (0000 corresponds to pin inactive)
- confirm with **"Ok"**
 - select CHANGE and press **"Ok"** to enter the new PIN code. Use the keys **"C1"** and **"C2"** to enter the numbers one by one that make up the code and press **"Ok"** to confirm them
 - select RESET to deactivate the PIN code request
- press **"Ok"** to confirm.
- The following message appears on the display $\Sigma \Delta$ ($\Delta \Sigma$ in the case of reset).

If the PIN code request is active, the keypad will be locked approx. 3 minutes after the keypad was last pressed. At this point, when pressed again, a request to enter the PIN code will appear.

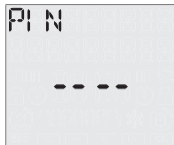

To unlock the instrument, enter the PIN code, according to this rule:

- key "**↵**": 1
- key "**C1**": 2
- key "**C2**": 3
- key "**OK**": 4

For example, pin: 3411 **"C2" "OK" "↵" "↵"**

SETTING RESET menu

This menu is used to reset all settings that were made, restoring the factory values:

Date format	dd--mm--yy
CET / DST change	automatic
- summer time change	Last Sunday in March 2:00 am
- winter time change	Last Sunday in October 3:00 am
Correction	
- sunrise	0 minutes
- sunset	0 minutes
PIN request	0000 - deactivated

To reset the settings

- select RESET SETTINGS with the "**C1**" and "**C2**" keys
- confirm with "**OK**"
- confirm again with "**OK**"
- the following message appears on the display **RESET**

HOUR METER MENU

The hour meter function indicates the total time in which the output remained in the on status.

The hour meter range is between 0 and 99999 hours, when the maximum limit is reached, it is automatically reset.

To display the hour meter value:

- from the main page, press “←”
- select HOUR CNT with “C1” and “C2”
- press “Ok” to confirm
- choose with “C1” and “C2”, in the case of GLX+Q 1 2COM 16A 2M AST IR, sets program 1 on relay 1.
- press “Ok”. The total use is displayed
- press “Ok” again to access the hour meter reset option. Press “Ok” again to confirm or “←” to exit without resetting.
- The message `WORKED` appears on the display to indicate the change that was made.

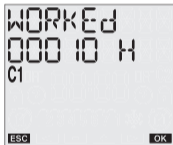

RESET MENU

The instrument's default status can be reset with the reset function.

There are 4 different resets available:

- reset settings: deletes all settings that were made
- reset programmes: deletes all saved programs
- reset hour meter: resets the operating time hour meter
- reset all: reset settings + reset programs + reset hour meter

To perform the reset:

- press “←” to access the menu
- select RESET with the keys “C1” and “C2” and press “Ok”
- use the keys “C1” and “C2” to select one of the above listed resets and press “Ok”
- press “Ok” to confirm.

To perform a complete instrument reset, restoring the factory settings, use a sharp instrument to press the “R” key. This deletes all the settings that were made and restores the default conditions.

IR INTERFACE

The switches (GLX+Q 1 1COM 16A 2M AST IR and GLX+Q 1 2COM 16A 2M AST IR) have an IR interface that makes it easy to exchange programs between the instrument and its remote control.

Attention: the IR interface can only be activated if **GLX+Q AST** is powered by the mains network.

In this way, an instrument can be programmed, then the program can be copied to a remote control and then duplicated in other instruments, without having to repeat the programming step by step.

The program exchange remote control is not provided with the instrument but can be purchased separately as an accessory:

Code	Model	Description
687456	GLX+IR	IR remote control Ita/Eng/Fra/Deu/Esp

There are two basic functions in this operating mode:

- **COPY**: consists in transferring the programs from a **GLX+Q AST** to the remote control
- **PASTE**: consists in transferring the programs from a remote control to one or more than one **GLX+Q AST** instruments at the same time.

Copy function

To transfer a program from **GLX+Q AST** to the remote control, first:

- generate a program with the traditional method on **GLX+Q AST** (see "Automatic programming")
- activate the reception mode on the remote control (see the relative instruction sheet)
- activate the transmission on **GLX+Q AST**, holding down the "Ok" key for **3 seconds**

The following message will appear on the display

IR ENABLE TRANSMI TE

- press the "Ok" key again to confirm the start of transmission or "↵" to cancel the transmission
- during the transmission, the following message will appear on the display DATA OUT (DATA IN on the remote control display) and the remote control will emit "bips". When completed, the following message is displayed TRANSMI TE DONE.



3 seconds



Paste function

To transfer a program from the remote control to one or more **GLX+Q AST**, first:

➤ connect the **GLX+Q AST** clock to the mains network

➤ press the “**R**” key to reset the instrument and activate the reception mode. The following message will appear on the display **R E C E I V E D F R I L E D**

➤ activate the transmission on the remote control and select which program to send (see the instructions for the remote control)

➤ during the transmission, the following message will appear on the display **T R A N S M I T T I N G** (on the remote control display) and the remote control will emit “bips”. When completed, the following message is displayed **T R A N S M I T T I N G D O N E**.

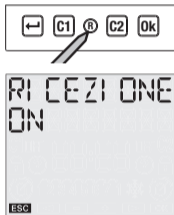

*problem with the transmission is signalled with the message **R E C E I V E D F R I L E D** on the clock's display.*

At this point, the programs and date and time settings are transferred to the instrument and it is ready to operate with the transferred parameters.



Note: during transmission, point the remote control towards the front of the instrument to facilitate the transmission. A possible

BATTERY REPLACEMENT

The battery charge level can be checked:

- automatically by the instrument once a week
- manually, hold down the “**⏻**” key on the main page for 3 seconds.

If the battery charge level is lower than the specific threshold, the following message will appear on the first row of the display **ቤገፎፍገፍ**. In this case, replace the battery as soon as possible.

To replace the battery:

- disconnect the power supply
- remove the cover from the battery compartment, turning it anticlockwise
- replace the battery and replace the cover, turning it clockwise
- connect the power supply

In order to retain the programming and settings, the time that passes between removing the old battery and inserting the new one must not exceed 60 seconds.



**Use CR-2032 batteries only.
Throw away the run down batteries in
compliance with current regulations on the
disposal of harmful waste.**

REFERENCE STANDARDS

Compliance with Community Directives

2014/35/EU (low voltage)

2014/30/EU (E.M.C.D.)

is declared in reference to the harmonized standard:

• **EN 60730-2-7**



GENERAL ELECTRIC

41 Woodford Avenue
Plainville, CT 06062 - USA